

Water Pressure Transmitter XY-PTW

Typical Feature

- Measurement Range 0-1MPa,0-1.6MPa, offer customized range
- Output Single 4-20mA, Power Supply 12-36 VDC (Typical 24VDC)
- Anti-frequency conversion interference design
- Common connect joint for installation easily
- Compact size saves installation room
- Customized structure diversification is available









Brief Introduction

XY-PTW Pressure Transmitter is a water pressure sensor, used to frequency converter water supply system, Pump, water supply equipment, and automatic machine; It has Anti-frequency conversion interference circuit to ensure the output signal is stable in the water supply system. At the same time, the excellent circuit compensate migration, sensitivity, temperature and nonlinear precision, thus XY-PTW has many characteristics, such as high concentration, small volume, high precision, good consistency, strong anti-interference ability and fast response speed.

XY-PTW Water Supply Pressure Sensor has stainless steel shell and joint, IP65 Ingress protection, powered by 12~36 VDC(Typical 24VDC), standard electrical signal output 4-20mV by 2-Wire cable, measurement Range 0-1MPa and 0-1.6 MPa, others customized measurement range is available, Thoughtful specialized electric circuit design, accuracy 0.5% FS; Long-Term Stability $\pm 0.02\%/FS/Year$.

Machinal joint include Thread, Flush Diaphragm, Clamp, Flange, Radiator and Differential Two-way Fitting.

Suggested Applications

-  Water Works
-  Water Supply System,
-  Water Supply Equipment,
-  Automatic Machine
-  Fire Protection System
-  Agricultural Irrigation
-  Customized Applications

More details for XY-PTW, please contact us.

Specification

Model	XY-PTW
General Pressure Range	0-1MPa,0-1.6MPa, Offer customized range
Pressure Type	Gauge Pressure Test
Dimension	Diameter $\Phi 27$
Overload Capacity	200%

Output Single	4-20mA
Power Supply	12-36 VDC (Typical 24VDC)
Insulating Strength	500VDC
Accuracy	0.5%FS
Long-Term Stability/Year	Typical: $\pm 0.2\%$ FS/Year
Response Time	$\leq 1\text{ms}$
Operation Temperature	-20 ~ 80°C
Compensation Temperature	-10 ~ 60°C
Connect Joint	M20*1.5 G1/2
IP Protection Class	IP65

Dimension(mm)

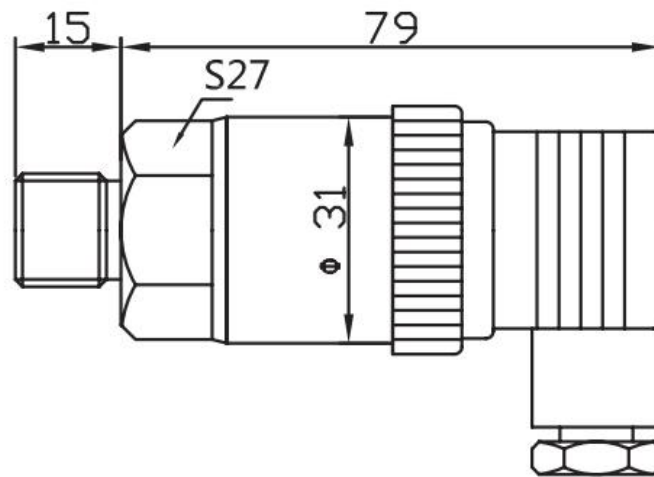

Mechanical Connection(mm)

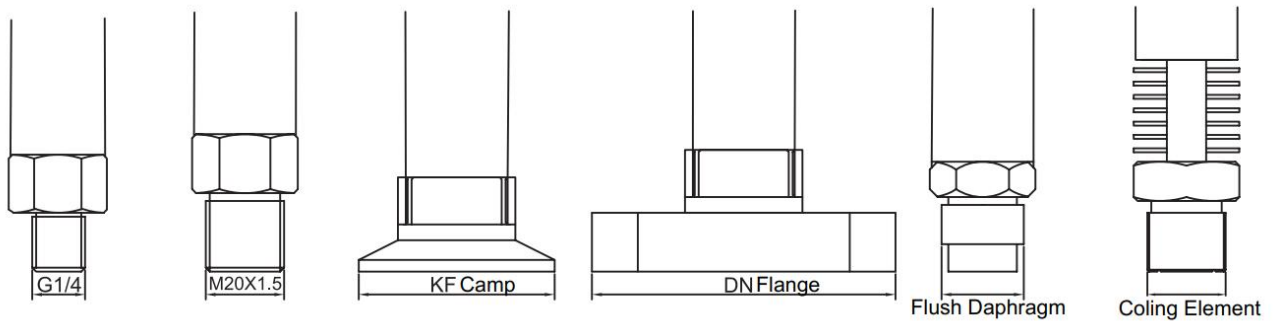

Electronic Connection

4-20mA(2-Wire)	Input +	Red
	Output+	Black
0-10V,0-5V(3-Wire)	Input +	Red
	Input -	Black
	Output+	Green

How To Order

KV-	PG	280	E	P	60M	I	P2	J	M3	B1	T1	L		
	Category	Type	Setup	Pressure Connection	Pressure Range	Accuracy	Power	Output	Thread	Electrical Connection	Medium Temperature	Additional		
PG	Pressure Gauge	200 High Accuracy	E Lower Mount	None	XK (0-XkPa)	1	0.40%	P0 Battery	R RS485	M1 M20*1.5	B Cable Outlet	T1 -5~40°C	LC LCD Display	
		210 High Accuracy Pressure&Temperature	Z Panel Mount	P Diaphragm Seals	XB (0-XBar)	2	0.20%	P2 24V	A 4-20mA	M2 G1/4	C Circular Connector	T2 -20~80°C	LE LED Display	
		270 Explosion-Proof	G Wireless	DP Differential Pressure	XM (0-XMPa)	3	0.10%	P4 220V	J1 Relay	M3 G1/2	CC Customized	T9 Customized	T1 Explosion-Proof	
		280 80mm Dial Size LCD Display	F Peak Record	KF Clamp	CC Customized	4	0.50%	P5 380V	J2 Dual Relay	M4 1/2NPT				
		200 60mm Dial Size	V Vacuum Switch	DN Flange		5	0.25%	P6 12V	CC Customized	M5 1/4NPT				
		300 100mm Dial Size	W Water Pump Switch	9999 Customized		9	Customized	P9 Customized		M7 2G1/4				
		380 80mm Dial Size LED Display								M9 Customized				
		560 Digital Remote-transmission												
		625 Contact 60mm Dial Size												
		825 Contact 80mm Dial Size												
		925 Contact 90mm Dial Size												
		PS	Pressure Switch	628 60mm Dial Size										
828 80mm Dial Size														
928 100mm Dial Size														
650 Switch Box with Plactic Shell														
PC	Pressure Control	600 60mm Dial Size												
		800 80mm Dial Size												
		900 100mm Dial Size												

Remark: 1. This form is for whole Pressure Measurement and Pressure Control products, please read Product Date Sheet to get reference informations
2. If you may not find right information in this form, please contact us to get future details

Shanghai Xuan Precision Technology Co., Ltd.

Address: No. 969, Yunshan Road Pudong District Shanghai City China

Tel: +86 21 59241315

Email: sales@xvyanprecision.com

Website: www.xvyanprecision.com

Product Manager: Tyler Tou

Cell: +86 189 1797 0680

Email: ttao@Xuyanpercision.com